

## Coiled Tubing Unit

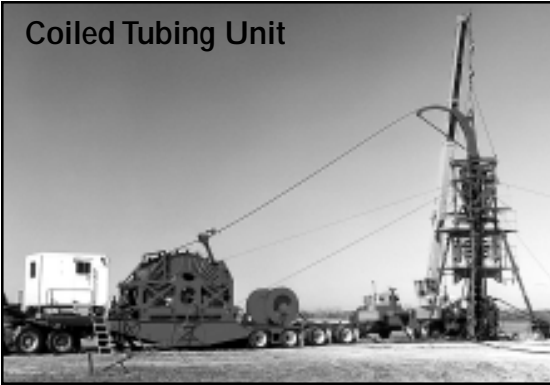

### Applications

Halliburton provides coiled tubing services for many applications—everything to help you reduce oil and gas well expenses from start to finish including

- Drilling
- Horizontal well services/logging and perforating
- Stimulation
- Fluid displacement
- Sand Control
- Coiled-tubing-conveyed perforating
- Wellbore cleanout
- Remedial cementing
- Setting and retrieving bridge plugs
- Flowline cleanup and repair
- Flow control of horizontal and deviated completions
- Fishing
- Nitrogen jetting
- Scale removal with Hydrablast® services

### Products

Halliburton has more than 130 coiled tubing units worldwide with capacities ranging from 3/4-in. to 3 1/2-in. coiled tubing pipe sizes.

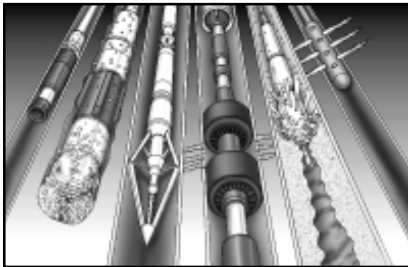

## DEPTHPRO™ WIRELESS COILED TUBING COLLAR LOCATOR

The DepthPro™ CT collar locator allows operators to accurately determine the location of various equipment and points in the wellbore without utilizing electric line inside of the coil. This patented technology expands the cost-effective capabilities of coiled tubing and is now being introduced by Halliburton. Proven applications include:

- spot perforating guns
- locate nipple profiles, ends of tubing and other equipment
- spot production packers, bridge plugs, squeeze packers, and inflatables
- spot chemical or jet cutters
- place sand-control fluids and chemicals
- place cement
- provide better depth correlation during CT fishing operations

**The DepthPro CT collar locator provides the depth accuracy of a wireline collar locator and works on any coiled tubing. Other features include:**

- Decreases the need for cumbersome depth-prediction calculations
- This battery-operated tool sends a pressure pulse signal to the surface to indicate the location of collars.
- Flow capabilities include acid or cement.
- An API log is generated for correlation purposes.



**QT-700®****Coiled Tubing Manufactured Product**

QT-700® is a 70,000 psi minimum yield strength continuously milled tubing produced by Quality Tubing, Inc. to meet Halliburton Energy Services material specification 70.99985. The coiled tubing is milled, to the length required, from flat strip that is joined end-to-end using a patented high quality 45 degree bias-weld process. When milled, the strip bias-weld is distributed along a helix in the finished tube. The bias-weld process eliminates tube-to-tube butt welds which significantly enhances reliability and service life of the coiled tubing.

The coiled tubing contains a longitudinal seam weld that is full annealed to achieve a uniform metallurgical structure. The tubing is eddy current tested to be defect-free and full body stress relieved. Other tests, such as hardness, tensile strength, tensile elongation, flattening, flare, drift and hydrostatic pressure tests are performed on the finished tubing to insure that it meets Halliburton specifications.

The material used to manufacture QT-700® is a modification of ASTM A-606 Type 4 steel that provides enhanced atmospheric corrosion resistance. Chemical composition of this high strength, low alloy (HSLA) steel is given on the following page along with mechanical properties of the coiled tubing.

QT-700® coiled tubing is manufactured to be suitable for sour (H<sub>2</sub>S) service.

Note: For the appropriate sizes, QT-700® can be routinely ordered as a Tapered string, Flash-Free™, or as a string with an electric wireline installed.

**QT-700****Material Specifications**

**Alloy:** ASTM A-606, Type 4 Modified

**Typical Chemistry:**

C	Mn	P	S	Si	Cr	Cu	Ni
0.10-0.14	0.70-0.90	0.025 max	0.005 max	0.30-0.50	0.50-0.70	0.25 max	0.20 max

**Mechanical Properties:**

Minimum Yield Strength	70,000 psi (552 N/mm <sup>2</sup> )
Minimum Ultimate Tensile Strength	80,000 psi (621 N/mm <sup>2</sup> )

**QT-800®****Coiled Tubing Manufactured Product**

QT-800® is a 80,000 psi minimum yield strength tube developed to fill the need for a higher strength coiled tubing product and that would still be suitable for use in sour (H<sub>2</sub>S) service. As coiled tubing applications extend to higher pressure wells, QT-800® offers increased cycle life and reduced ovality growth required for these demanding applications. The higher strength allows QT-800® to work under the higher stress loads imposed by drilling and fishing tools.

Like the QT-700® product, QT-800® is a continuously milled tubing produced by Quality Tubing, Inc. and is manufactured to meet Halliburton Energy Services material specification 70.99986. QT-800® coiled tubing is also milled from strip that has been joined end-to-end using a patented high quality 45 degree bias-weld, eliminating the need for butt welds.

The coiled tubing contains a longitudinal seam weld that is full annealed to achieve a uniform metallurgical structure. The tubing is eddy current tested to be defect-free and full body stress relieved. Other tests, such as hardness, tensile strength, tensile elongation, flattening, flare, drift and hydrostatic pressure tests are performed on the finished tubing to insure that it meets Halliburton specifications.

The material used to manufacture QT-800® is a modification of ASTM A-606 Type 4 steel that provides enhanced atmospheric corrosion resistance. Chemical composition of this high strength, low alloy (HSLA) steel is given on the following page along with mechanical properties of the coiled tubing.

Note: For the appropriate sizes, QT-800® can be routinely ordered as a Tapered or Tru-Taper® string, Flash-Free™, or as a string with an electric wireline installed.

**QT-800****Material Specifications**

**Alloy:** ASTM A-606, Type 4 Modified

**Typical Chemistry:**

C	Mn	P	S	Si	Cr	Cu	Ni	Mo
0.10-0.16	0.70-0.90	0.025 max	0.006 max	0.30-0.50	0.50-0.70	0.25 max	0.20 max	0.21 max

**Mechanical Properties:**

Minimum Yield Strength	80,000 psi (552 N/mm <sup>2</sup> )
Minimum Ultimate Tensile Strength	90,000 psi (621 N/mm <sup>2</sup> )

## QT-1000™

### Coiled Tubing Manufactured Product

In response to further increased demands, Quality Tubing, Inc. has developed QT-1000™ which has significantly higher strength than QT-700® or QT-800®. The higher strength of QT-1000™ (100,000 psi minimum yield strength) allows it to be used in highly demanding applications where higher maximum stresses, allowable pull, internal or collapse pressure ratings may be needed.

QT-1000™ is made to the same exacting demands as the other coiled tubing products made by Quality Tubing, Inc. QT-1000™ is a continuously milled tubing and is manufactured to meet Halliburton Energy Services material specification 70.99434. QT-1000™ coiled tubing contains a longitudinal seam weld that is full annealed to achieve a uniform metallurgical structure. The tubing is eddy current tested to be defect-free and full body stress relieved. Other tests, such as hardness, tensile strength, tensile elongation, flattening, flare, drift and hydrostatic pressure tests are performed on the finished tubing to insure that it meets Halliburton specifications.

QT-1000™ is a product that is sour gas (H<sub>2</sub>S) limited as its hardness may be above 22 HRC (Rockwell C). The limits of usage in H<sub>2</sub>S containing environments are still being defined. Contact Duncan Technology Coiled Tubing group or Quality Tubing for specific recommendations.

The material used to manufacture QT-1000™ is a modification of ASTM A-607 Type 4 steel that provides enhanced atmospheric corrosion resistance. Typical chemical composition of this high strength, low alloy (HSLA) steel is given below along with mechanical properties of the coiled tubing.

Note: For the appropriate sizes, QT-1000™ can be routinely ordered as a True-Tapered string, Flash-Free™, or as a string with an electric wireline installed.

## QT-1000™

### Material Specifications (Ref: HES spec 70.99434)

**Alloy:** ASTM A-607, Type 4 Modified

#### Typical Chemistry:

C	Mn	P	S	Si	Cr	Cu	V
0.12	1.48	0.010	0.003	0.38	0.62	0.27	0.07

#### Mechanical Properties:

Minimum Yield Strength:	100,000 psi (690 N/mm <sup>2</sup> )
Minimum Ultimate Tensile Strength	110,000 psi (759 N/mm <sup>2</sup> )

#### Coiled Tubing Material Properties

Young's Modulus	30 x 10 <sup>6</sup> psi or (21.55 x 10 <sup>3</sup> kg/mm <sup>2</sup> )
Shear Modulus	11.7 x 10 <sup>6</sup> psi or (8.2 x 10 <sup>3</sup> kg/mm <sup>2</sup> )
Poisson's Ratio	0.30
Coefficient of Thermal Expansion	6.51 x 10 <sup>-6</sup> /°F or (11.7 x 10 <sup>-6</sup> /°C)
Steel Density	0.283 lbs/in <sup>3</sup> or (7.86 g/cm <sup>3</sup> )

## COILED TUBING TECHNICAL DATA

Specified Outside Diameter <b>D</b> in.	Wall Thickness* <b>t</b> in.	Inside Diameter <b>d</b> in.	Wall Cross- Section Area <b>At</b> sq. in.	Weight <b>W</b> lb/ft	Volume Internal Capacity <b>Vi</b> bbl/1000 ft	External Capacity <b>Vo</b> bbl/1000 ft
1.000	0.080	0.8400	0.2312	0.7861	0.6854	0.9714
1.000	0.087	0.8260	0.2495	0.8483	0.6628	0.9714
1.000	0.095	0.8100	0.2701	0.9182	0.6373	0.9714
1.000	0.102	0.7960	0.2878	0.9783	0.6155	0.9714
1.000	0.109	0.7820	0.3051	1.037	0.5940	0.9714
1.250	0.080	1.090	0.2941	1.000	1.154	1.518
1.250	0.087	1.076	0.3179	1.081	1.125	1.518
1.250	0.095	1.060	0.3447	1.172	1.091	1.518
1.250	0.102	1.046	0.3679	1.251	1.063	1.518
1.250	0.109	1.032	0.3907	1.328	1.035	1.518
1.250	0.125	1.000	0.4418	1.502	0.9714	1.518
1.250	0.134	0.9820	0.4698	1.597	0.9367	1.518
1.250	0.156	0.9380	0.5362	1.823	0.8547	1.518
1.500	0.095	1.310	0.4193	1.426	1.667	2.186
1.500	0.102	1.296	0.4480	1.523	1.632	2.186
1.500	0.109	1.282	0.4763	1.619	1.597	2.186
1.500	0.125	1.250	0.5400	1.836	1.518	2.186
1.500	0.134	1.232	0.5750	1.955	1.474	2.186
1.500	0.156	1.188	0.6587	2.239	1.371	2.186
1.500	0.175	1.150	0.7285	2.476	1.285	2.186
1.750	0.109	1.532	0.5619	1.910	2.280	2.975
1.750	0.125	1.500	0.6381	2.169	2.186	2.975
1.750	0.134	1.482	0.6803	2.313	2.134	2.975
1.750	0.156	1.438	0.7812	2.666	2.009	2.975
1.750	0.175	1.400	0.8659	2.944	1.904	2.975
1.750	0.188	1.374	0.9225	3.136	1.834	2.975
2.000	0.109	1.782	0.6475	2.201	3.085	3.886
2.000	0.125	1.750	0.7363	2.503	2.975	3.886
2.000	0.134	1.732	0.7855	2.671	2.914	3.886
2.000	0.156	1.688	0.9037	3.072	2.768	3.886
2.000	0.175	1.650	1.0033	3.411	2.645	3.886
2.000	0.188	1.624	1.0702	3.638	2.562	3.886
2.000	0.203	1.594	1.1460	3.896	2.468	3.886
2.375	0.109	2.157	0.7760	2.638	4.520	5.479
2.375	0.125	2.125	0.8836	3.004	4.386	5.479
2.375	0.134	2.107	0.9434	3.207	4.312	5.479
2.375	0.156	2.063	1.0875	3.697	4.134	5.479
2.375	0.175	2.025	1.2095	4.112	3.983	5.479
2.375	0.188	1.999	1.2917	4.391	3.882	5.479
2.375	0.203	1.969	1.3852	4.709	3.766	5.479
2.875	0.125	2.625	1.0799	3.671	6.694	8.029
2.875	0.134	2.607	1.1539	3.923	6.602	8.029
2.875	0.156	2.563	1.3326	4.530	6.381	8.029
2.875	0.175	2.525	1.4844	5.046	6.193	8.029
2.875	0.188	2.499	1.5870	5.395	6.066	8.029
2.875	0.203	2.469	1.7041	5.793	5.922	8.029
3.500	0.134	3.232	1.4170	4.817	10.150	11.900
3.500	0.156	3.188	1.6389	5.571	9.873	11.900
3.500	0.175	3.150	1.8280	6.215	9.639	11.900
3.500	0.188	3.124	1.9561	6.650	9.480	11.900
3.500	0.203	3.094	2.1026	7.148	9.299	11.900

## COILED TUBING TECHNICAL DATA

Tubing Capacity @ 70 kpsi yield strength			Tubing Capacity @ 80 kpsi yield strength			Tubing Capacity @ 100 kpsi yield strength		
Internal Pressure	Tensile Load	Torque	Internal Pressure	Tensile Load	Torque	Internal Pressure	Tensile Load	Torque
<b>P<sub>y</sub></b>	<b>Q<sub>y</sub></b>	<b>T<sub>y</sub></b>	<b>P<sub>y</sub></b>	<b>Q<sub>y</sub></b>	<b>T<sub>y</sub></b>	<b>P<sub>y</sub></b>	<b>Q<sub>y</sub></b>	<b>T<sub>y</sub></b>
<i>psi</i>	<i>lb</i>	<i>lb-ft</i>	<i>psi</i>	<i>lb</i>	<i>lb-ft</i>	<i>psi</i>	<i>lb</i>	<i>lb-ft</i>
10250	15420	323	11720	17620	369	14640	22030	462
11180	16730	346	12770	19130	395	15970	23910	494
12230	18210	371	13970	20810	424	17460	26010	529
13130	19480	391	15010	22260	447	18760	27820	559
14030	20720	410	16040	23680	469	20040	29600	586
8259	19540	526	9438	22340	601	11798	27920	752
9013	21240	566	10300	24280	646	12876	30350	808
9870	23160	609	11280	26460	696	14100	33080	870
10620	24810	645	12130	28350	737	15170	35440	922
11360	26440	680	12980	30220	777	16220	37770	971
13030	30080	755	14890	34380	863	18610	42980	1078
13960	32080	794	15950	36670	907	19940	45840	1134
16170	36830	881	18490	42090	1007	23110	52610	1258
8269	28100	907	9451	32120	1036	11813	40150	1295
8899	30140	963	10170	34450	1101	12714	43060	1376
9530	32160	1018	10890	36750	1164	13610	45940	1455
10950	36680	1137	12510	41920	1300	15640	52400	1625
11740	39180	1201	13420	44770	1372	16770	55970	1715
13650	45130	1344	15600	51570	1536	19500	64470	1920
15260	50100	1456	17440	57250	1664	21800	71570	2080
8200	37870	1425	9371	43280	1329	11714	54110	2036
9433	43280	1600	10780	49460	1828	13476	61830	2285
10120	46270	1693	11570	52880	1935	14460	66100	2418
11790	53430	1907	13470	61060	2180	16840	76330	2725
13200	59440	2077	15090	67930	2374	18860	84920	2968
14160	63460	2186	16180	72530	2499	20230	90660	3123
7195	43590	1901	8223	49820	2173	10278	62270	2716
8283	49880	2141	9466	57000	2447	11833	71250	3058
8891	53360	2270	10160	60980	2595	12702	76230	3243
10370	61730	2570	11850	70550	2937	14810	88190	3672
11630	68790	2811	13290	78650	3213	16610	98270	4016
12480	73530	2967	14260	84030	3391	17830	105000	4238
13450	78900	3137	15380	90170	3586	19220	112700	4482
6075	52170	2743	6943	59620	3135	8679	74530	3919
6999	59770	3102	7999	68310	3545	9998	85390	4431
7516	64000	3296	8590	73140	3767	10740	91430	4709
8774	74180	3751	10030	84780	4287	12530	106000	5359
9850	82810	4122	11260	94640	4711	14070	118300	5889
10580	88620	4364	12090	101300	4987	15120	126600	6234
11420	95230	4632	13050	108800	5293	16310	136000	6617
5798	72970	4660	6626	83390	5326	8283	104200	6658
6228	78180	4963	7118	89350	5672	8898	111700	7089
7277	90790	5676	8316	103800	6487	10400	129700	8108
8177	101500	6263	9345	116000	7158	11680	145000	8947
8790	108700	6650	10050	124300	7600	12560	155300	9500
9494	117000	7082	10850	133700	8094	13560	167100	10120
5128	95910	7525	5860	109600	8600	7325	137000	10750
5995	111500	8643	6851	127500	9877	8564	159300	12350
6740	124900	9572	7703	142700	10940	9629	178400	13670
7249	133900	10190	8285	153000	11640	10360	191300	14550
7834	144200	10880	8953	164800	12440	11190	206000	15540

## GENERAL ENGINEERING INFORMATION

### DEFINITIONS

#### Pipe Body Yield Load

The Pipe Body Yield Load is defined as the axial tension load (in the absence of pressures or torque) which produces a stress in the tube equal to the specified minimum yield strength (SMYS) in tension;

$$L_y = p \times (D - t) \times t \times \text{SMYS}$$

Where:

- $L_y$  = Pipe Body Yield Load (lbs)
- SMYS = Specified Minimum Yield Strength (psi)
- D = Specified Outside Diameter (inches)
- t = Specified Wall Thickness (inches)

**Inside Diameter** is equal to the CT OD, minus twice the specified WT:

$$d = D - 2t$$

**Wall Cross-Section Area** is defined by specified OD and specified WT

$$A_t = \pi (D - t) t$$

The **Weight** per foot of CT length is calculated by specified OD, specified WT, and applying steel densing of 0.2833 lb/in<sup>3</sup>

$$W = 10.68 (D - t)t \quad \text{lb/ft}$$

**Internal Volume Capacity** of 1000 ft long non-tapered CT string (at constant WT and OD) is defined as

$$V_i = 0.971426d^2 = 0.971426 (1-2/\alpha)^2 D^2 \quad \text{bbl/1000 ft}$$

**Internal Volume Capacity** of 1000 ft long tru-tapered CT segment is defined as the volume of a frustum cone

$$V_i = \frac{0.971426^2}{3} (d_1 + d_1d_2 + d_2^2) \quad \text{bbl/1000 ft}$$

**External Volume Capacity** of 1000 ft long CT string is defined as a volume for 1000 ft long a solid cylinder with diameter D

$$V_o = 5.45415 D^2 \quad \text{ft}^3/1000 \text{ ft}$$

$$V_o = 40.7999 D^2 \quad \text{gal/1000 ft}$$

$$V_o = 0.971426 D^2 \quad \text{bbl/1000 ft}$$

where D - CT OD in in.

**Displacement** is the material (metallic) volume occupied by 1000 ft long CT string

$$V = V_o - V_i$$

where  $V_o$  and  $V_i$  are volumes in consistent units.

**Yield Pressure, Load, and Torque Capacities and CP** are defined using:

- CT inner surface stress state,
- distortion energy failure theory (von Mises),
- production maximum OD ( $DD = D + 0.01$ ),
- production minimum WT ( $tt = t - 0.005$ ), and
- ratio  $\alpha = \frac{DD}{tt} = \frac{\text{Production Maximum OD}}{\text{Production Minimum WT}}$



**Yield Internal Pressure Capacity** is a pressure,  $P_y$ , which induces combined stress on inner surface of the CT equal to the specified minimum yield strength,  $\sigma_y$ . It is assumed that the pressure does not produce axial tensile load ("open end" tubing),

$$P_y = \frac{\sigma_y}{\sqrt{4M^2 - 2M + 1}}$$

**Yield Load Capacity** is an axial force,  $Q_y$ , which induces a stress in the CT cross-section equal to the specified minimum yield strength,  $\sigma_y$

$$Q_y = \sigma_y \pi (DD-tt) tt$$

**Yield Torque Capacity** is the torque,  $T_y$ , which produces shear stress on the CT outer surface equal to the specified minimum yield strength in shear,  $T_y = \sigma_y / \sqrt{3}$

$$T_y = \frac{\sigma_y \pi}{192 \sqrt{3}} DD^3 [1 - (1-2/\alpha)^4] \text{ lb-ft}$$

CP is a function of CT ovality ( $O_v = (D_{\max} - D_{\min})/D$ ), applied internal pressure,  $P_i$ , applied axial force,  $Q$ , and  $D/t$ -ratio. The condition of the CT in service cannot be considered as "perfectly round". Therefore, CT should always be considered as oval, with minimum ovality of 0.02 (2%).

CP for CT with ovality  $O_v=0$  (round tubing),  $=0.02$ , and  $=0.05$  is in the Coiled Tubing Collapse Pressures Table (pages 16 & 17) for various CT sizes and material grades. For ovality 2% and 5% CP is tabulated at zero axial force ( $Q=0$ ) and at axial force equal to one half of yield load capacity ( $Q=Q_y/2$ ).

In general, if external pressure is combined with internal pressure,  $P_i$ , and/or with axial force,  $Q$ , and CT ovality is other than in the Coiled Tubing Collapse Pressures Table (pages 16 & 17), then CP should be calculated using formulas

$$P_{co} = g - \sqrt{g^2 - f}$$

where

$$g = \frac{\sigma_y K_y}{4M} + (2 + 3 \cdot \alpha \cdot O_v) \frac{P_{ce}}{4}$$

$$f = \frac{\sigma_y K_y P_{ce}}{2M}$$

## **US CUSTOMARY UNITS: CONVERSION TO METRIC UNITS**

*In Accordance with Guidelines Given in API Spec 5CT*

### **Outside Diameter**

$$D_M = 25.4 \times D$$

Where:

$$D_M = \text{Outside Diameter, mm} \\ \text{rounded to nearest 0.01 mm.}$$

$$D = \text{Specified Outside Diameter, inches}$$

### **Wall Thickness**

$$t_m = 25.4 \times t$$

Where:

$$t_m = \text{Wall Thickness, mm} \\ \text{rounded to nearest 0.01 mm}$$

$$t = \text{Specified Wall Thickness, inches}$$

### **Inside Diameter**

$$d_m = 25.4 \times d$$

Where:

$$d_m = \text{Inside Diameter, mm} \\ \text{rounded to nearest 0.01 mm.}$$

$$d = \text{Calculated Inside Diameter, inches}$$

### **Plain End Weight**

$$P_1 = 0.0246615 (D_m - t_m) t_m$$

Where:

$$P_1 = \text{Metric Plain End Mass/Meter, kg/m} \\ \text{rounded to nearest 0.01 kg/m.}$$

$$D_m = \text{Metric Outside Diameter, mm}$$

$$t_m = \text{Metric Wall Thickness, mm}$$

### **Specified Minimum Yield Strength**

$$SMYS_m = 0.00689476 \times SMYS$$

Where:

$$SMYS_m = \text{Specified Min. Yield Strength, N/mm}^2 \\ \text{rounded to nearest 1 N/mm}^2.$$

$$SMYS = \text{Specified Minimum Yield Strength, psi}$$

## Torsional Strength

1 lb-ft = 1.35582 Newton-meters (N-m),  
 Values in tables are rounded to the  
 nearest 10 N-m.

## Pipe Body Yield Load

$$L_{yM} = 4.448222 \times L_y$$

Where:

$L_{yM}$  = Pipe Body Yield Load, N  
 rounded to nearest 100 N (0.1kN)

$L_y$  = Pipe Body Yield Load, lbs

## Internal Yield Pressure

$$P_{rM} = 0.00689476 \times P_r$$

Where:

$P_{rM}$  = Metric Internal Yield Pressure, MPa  
 rounded to nearest 0.1 MPa

$P_r$  = Internal Yield Pressure, psi

## Collapse Pressure

$$P_{cM} = 0.00689476 \times P_c$$

Where:

$P_{cM}$  = Metric Collapse Pressure, MPa  
 rounded to nearest 0.1 MPa

$P_c$  = Collapse Pressure, psi



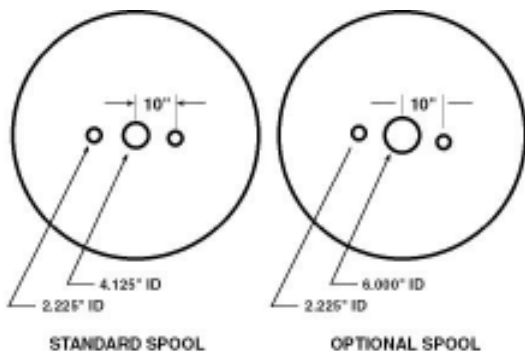

Flange Height "A"	Core Diameter "B"	Inside Width "C"	Outside Width "D"	Spool Weight Empty lbs	Spool Weight (Crated) lbs
90"	48"	48"	58"	1,750	2,250
112"	72"	60"	70"	3,150	4,100
120"	72"	60"	70"	3,460	4,510
124"	72"	60"	70"	3,625	4,800
128"	72"	65"	75"	3,840	4,760
135"	82"	60"	70"	4,400	5,370
135"	82"	65"	75"	4,400	5,400
154"	92"	65"	75"	6,100	7,400
154"	98"	65"	75"	6,100	7,400
180"	112"	88.75"	96"	9,000	
180"	130"	88.75"	96"	9,000	
165"	130"	88.75"	96"	8,000	

## REEL CAPACITY CALCULATION

The pipe capacity of any reel can be found by following equations. Wrapping efficiency factors are used to account for nesting and spool width effects.

$p = .96$	Radial pitch factor: radial distance between adjacent layers divided by tubing OD
$k = 0.96$	Drum width utilization factor: number of coils per drum width divided by theoretical capacity, $w/d$
$C = 82$	Drum (core) diameter, <i>in.</i>
$W = 65$	Drum length (width), <i>in.</i>
$F = 135$	Flange Diameter, <i>in.</i>
$DD = 2.01$	Maximum production CT OD, <i>in.</i>
$m = \frac{W \cdot k}{DD} \quad m = 31$	Number of coils per drum length
$n = \text{floor} \left( \frac{F - C}{2 \cdot DD \cdot p} \right)$ $n = 13$	Total number of layers; floor means that an integer portion of an expression should be used
$j = 1..n$	Layer serial number
$d_j = C + DD + 2 \cdot DD \cdot p \cdot (j - 1)$	The <i>j</i> th layer diameter, defined by CT centerline, <i>in.</i>
$d_1 = 84.01$	The 1st layer diameter, <i>in.</i>
$d_n = 130.32$	The last layer diameter, <i>in.</i>
$d_{o_j} = d_j + DD$	The <i>j</i> th layer OD, defined by layer outermost cylinder (outer surface)
$d_{o_1} = 86.02$	The 1st layer OD, <i>in.</i>
$d_{o_n} = 132.33$	The last layer OD, <i>in.</i>
$H_j = \frac{1}{12} \cdot \pi \cdot (C + DD + DD \cdot j \cdot p - DD \cdot p) \cdot W \cdot \frac{k}{DD} \cdot j$	CT length at <i>j</i> layers, starting from bedlayer, <i>ft</i>
$H_1 = 683$	Capacity of the 1st layer, <i>ft</i>
$H_n = 11323$	Reel capacity, CT length at all <i>n</i> layers, <i>ft</i>

## Coiled Tubing, Drill Pipe and Casing Stretch Data

The stretch or elongation of oil well tubular material resulting from an applied pulling force is a commonly required determination. Robert Hooke (1635-1702) discovered the law (Hooke's law) that strain or distortion is proportional to stress or force if the elastic limit of the material is not exceeded. (The elastic limit of the material is the maximum stress that can be developed within it without causing permanent deformation or permanent stretch in oil field terms.)

The amount of stretch that will occur when a pull force is applied varies with the amount of pull, the length of the material being stretched, the elasticity of the material and its cross-sectional area, provided the elastic limit is not exceeded.

### General Stretch Formula:

$$\text{Where: } S = \frac{F \times L \times 12}{A_w \times E}$$

$S$  = stretch, in inches

$F$  = pull force, in pounds

$L$  = length, in feet

$E$  = modulus of elasticity, in pounds per square inch.  
(for steel,  $E = 30,000,000$  psi)

$A_w$  = pipe metal cross-section in square inches.

### Note:

It is a common misconception that the amount of stretch for oil field tubular material is affected by the grade of steel (J-55, N-80, etc.). This is not true, because the modulus of elasticity remains the same.

Higher grades of steel have greater elastic limits and can therefore be stretched farther before reaching their elastic limits than can the lower grades. The only factors that affect the amount of stretch are those shown in the preceding general stretch formula.

### Formula for stretch in Tubular Steel Products:

$$\text{Where: } S = \frac{F \times L}{A_w \times E}$$

$S$  = Stretch in inches

$F$  = Force in pounds

$L$  = Length in inches

$A_w$  = Pipe Metal Cross-section in sq. in.

$E$  = Elasticity Modulus of steel

= 30,000,000 psi

### Example:

15,000 ft of 1.50" x .095" Coiled Tubing with 20,000 lb pull would stretch how many inches?

$$S = \frac{20,000 \text{ lb} \times 180,000 \text{ in.}}{0.419 \text{ sq in} \times 30,000,000 \text{ psi}}$$

= 286 inches

## COLLAPSE PRESSURE

The collapse pressure in the absence of axial stress, P, for new, as-manufactured coiled tubing is calculated using the appropriate formula of API Bul 5C3 for Yield Strength, Plastic or Transition Collapse pressure, but using the specified wall thickness (t).

For coiled tubing in service, the condition of the tube cannot be considered "perfectly round". Coiled tubing should always be considered as oval, with a minimum ovality of 0.2 (2%). For standard coiled tubing sizes and material grades, collapse pressures at ovalities of 0.02 and 0.05 are calculated and listed in the following tables. When actual ovality is other than 0.02 or 0.05, these equations should be used.

### Collapse Pressure of Coiled Tubing: Example

#### Input:

#### QT-800, 1.50 in. OD x 0.109 in. WT, as the CT identification

D = 1.5		Specified CT OD, in.
t = 0.109		Specified CT WT, in.
DD = D + 0.01	DD = 1.51	CT OD, production maximum, in
tt = t - 0.005	tt = 0.104	Wall thickness, production minimum, in
Dmax = 1.57		Section major diameter, measured, in
Dmin = 1.45		Section minor diameter, measured, in
y = 80000		CT Yield Strength, psi
E = 30000000		Modulus of Elasticity, psi
u = 0.3		Poisson's Ratio
Qy = 36750		Tensile Load Capacity, from Table of CT Technical Data, lb
Q = 20000		Applied axial force in design section, lb
P = 2000		Applied Internal Pressure, psi
UF = 0.5		CT Utilization Factor, UF=0 for new CT, UF=1 for fully worn CT

#### EVALUATION:

$$C := \frac{2 \cdot E}{1 - \mu^2} \quad C = 65934066 \quad \text{Material Constant, psi}$$

$$SF := 0.8 \cdot 0.8 \left( UF^{1.5} \right) \quad SF = 0.739 \quad \text{Safety Factor}$$

$$\alpha := \frac{DD}{tt} \quad \alpha = 14.519 \quad \text{Ratio}$$

$$M := \frac{\alpha^2}{4 \cdot (\alpha - 1)} \quad M = 3.898 \quad \text{CT constant}$$

$$Ov := \frac{D_{\max} - D_{\min}}{D} \quad Ov = 0.08 \quad \text{Ovality index}$$



$$K_y := \frac{2 \cdot M \cdot P_i}{\sigma_y} - \frac{1}{2} \cdot \left( \frac{Q}{Q_y} + \frac{P_i}{\sigma_y} \right) + \sqrt{1 - \frac{3}{4} \cdot \left( \frac{Q}{Q_y} + \frac{P_i}{\sigma_y} \right)^2}$$

$$K_y = 0.78$$

Yield correction factor

$$P_{ce} := .7125 \cdot \left[ \frac{C}{\alpha \cdot (\alpha - 1)^2} + P_i \right]$$

$$P_{ce} = 19128$$

Elastic collapse pressure for round CT when internal pressure is applied, psi

$$P_{yo} := \frac{\sigma_y \cdot K_y}{2 \cdot M}$$

$$P_{yo} = 8007$$

Yield External Pressure Capacity, psi

$$P_c := \left( P_{yo}^{-2} + P_{ce}^{-2} \right)^{-\frac{1}{2}}$$

$$P_c = 7386$$

Collapse Pressure for Round CT with internal pressure &amp; axial load, psi

$$g := \frac{\sigma_y \cdot K_y}{4 \cdot M} + (2 + 3 \cdot Ov \cdot \alpha) \cdot \frac{P_{ce}}{4}$$

$$g = 30231$$

Factor

$$f := \frac{\sigma_y \cdot K_y \cdot P_{ce}}{2 \cdot M}$$

$$f = 153161456$$

Factor

$$P_{co} = g - \sqrt{g^2 - f}$$

$$P_{co} = 2649$$

Collapse pressure of oval CT with internal pressure and axial force, psi

$$PA_{co} := P_{co} \cdot SF$$

$$PA_{co} = 1959$$

Allowable collapse pressure, psi

COILED TUBING COLLAPSE PRESSURES								
Specified Outside Diameter	Wall Thickness	Weight	D / t Ratio	Specified Minimum Yield				
				70		0		
D in	t in	W lb/ft	DD/tt	0	0.02	Ovality, 0.05		
				Q=0	Q=0	Qy/2	Q=0	Tensile Qy/2
Collapse Pressure at Production Maximum OD								
1.000	0.080	0.7861	13.47	9624	6179	4189	4281	2902
1.000	0.087	0.8483	12.32	10440	7038	4727	4954	3334
1.000	0.095	0.9182	11.22	11360	7999	5332	5733	3834
1.000	0.102	0.9783	10.41	12150	8821	5852	6419	4274
1.000	0.109	1.037	9.712	12930	9627	6364	7106	4715
1.000	0.125	1.168	8.417	14660	11410	7502	8672	5721
1.250	0.080	1.000	16.80	6682	4308	3021	2902	2013
1.250	0.087	1.081	15.37	7863	5019	3464	3411	2342
1.250	0.095	1.172	14.00	9213	5824	3967	4010	2728
1.250	0.102	1.251	12.99	9948	6519	4401	4545	3072
1.250	0.109	1.328	12.12	10600	7204	4831	5086	3419
1.250	0.125	1.502	10.50	12060	8727	5792	6339	4223
1.250	0.134	1.597	9.767	12870	9560	6321	7048	4677
1.250	0.156	1.823	8.344	14770	11520	7575	8773	5786
1.500	0.095	1.426	16.78	6699	4319	3027	2909	2018
1.500	0.102	1.523	15.57	7685	4912	3397	3333	2292
1.500	0.109	1.619	14.52	8670	5501	3765	3767	2572
1.500	0.125	1.836	12.58	10240	6827	4594	4786	3227
1.500	0.134	1.955	11.71	10940	7555	5052	5370	3601
1.500	0.156	2.239	10.00	12600	9284	6145	6812	4526
1.500	0.175	2.476	8.882	13990	10719	7060	8058	5326
1.750	0.109	1.910	16.92	6590	4253	2986	2863	1988
1.750	0.125	2.169	14.67	8523	5414	3710	3702	2530
1.750	0.134	2.313	13.64	9509	6059	4113	4189	2843
1.750	0.156	2.656	11.66	10980	7600	5080	5406	3624
1.750	0.175	2.944	10.35	12220	8886	5893	6473	4309
1.750	0.188	3.136	9.617	13040	9743	6437	7206	4779
2.000	0.109	2.201	19.33	5028	3317	2397	2222	1569
2.000	0.125	2.503	16.75	6720	4331	3035	2918	2023
2.000	0.134	2.671	15.58	7672	4904	3393	3328	2288
2.000	0.156	3.072	13.31	9727	6288	4256	4365	2956
2.000	0.175	3.411	11.82	10840	7452	4987	5286	3547
2.000	0.188	3.638	10.98	11590	8230	5478	5924	3957
2.000	0.203	3.896	10.15	12430	9110	6035	6663	4431
2.375	0.109	2.638	22.93	3298	2323	1753	1568	1137
2.375	0.125	3.004	19.88	4724	3138	2283	2102	1491
2.375	0.134	3.207	18.49	5527	3614	2585	2422	1701
2.375	0.156	3.697	15.79	7488	4793	3323	3247	2237
2.375	0.175	4.112	14.03	9181	5805	3955	3996	2719
2.375	0.188	4.391	13.03	9918	6487	4381	4520	3056
2.375	0.203	4.709	12.05	10660	7262	4867	5133	3449
2.875	0.125	3.671	24.04	2958	2091	1598	1419	1036
2.875	0.134	3.923	22.36	3534	2454	1839	1653	1193
2.875	0.156	4.530	19.11	5155	3393	2445	2272	1603
2.875	0.175	5.046	16.97	6555	4232	2973	2848	1978
2.875	0.188	5.395	15.77	7513	4809	3333	3258	2244
2.875	0.203	5.793	14.57	8618	5471	3746	3744	2557
3.500	0.134	4.817	27.21	2285	1566	1238	1082	806
3.500	0.156	5.571	23.25	3174	2254	1708	1524	1107
3.500	0.175	6.215	20.65	4325	2905	2133	1948	1389
3.500	0.188	6.650	19.18	5112	3367	2428	2255	1591
3.500	0.203	7.148	17.73	6020	3910	2771	2625	1833

NOTES: 1. Collapse pressure for round CT (ovality (Dmax-Dmin)/D=0) is the yield strength, plastic, transition, or elastic collapse pressure by API Bull 5C3.

2. Collapse pressure due to ovality is in the solution by S. Timoshenko, *Strength of Materials, Part 2, Van Nostrand, 1954*. See also: *Computing Collapse Pressure*

## COILED TUBING COLLAPSE PRESSURES

Strength, <i>kpsi</i>		1 080					100				
		(Dmax - Dmin)/D									
0		0.02		0.05		0		0.02		0.05	
Tensile Load, <i>Q</i>											
Q=0	Q=0	Qy/2	Q=0	Qy/2	Q=0	Q=0	Q=0	Qy/2	Q=0	Qy/2	
(DD=D+0.01) and Minimum Wall (tt=t-0.005), <i>psi</i>											
10950	6940	4738	4812	3282	13100	8363	5798	5817	4016		
11940	7937	5360	5585	3778	14920	9647	6591	6792	4640		
12990	9051	6057	6480	4351	16230	11080	7479	7922	5363		
13890	10000	6656	7269	4856	17360	12300	8240	8919	5999		
14780	10930	7245	8059	5362	18470	13490	8986	9918	6637		
16750	12990	8550	9860	6520	20940	16110	10640	12190	8090		
7330	4770	3387	3232	2262	8470	5584	4070	3838	2735		
8695	5593	3901	3814	2640	10220	6633	4727	4565	3208		
10250	6528	4482	4501	3082	12210	7832	5470	5426	3764		
11370	7335	4984	5115	3476	13960	8871	6111	6198	4260		
12120	8129	5480	5737	3875	15150	9894	6744	6984	4763		
13790	9893	6588	7178	4798	17230	12160	8152	8804	5926		
14700	10860	7195	7992	5319	18380	13390	8923	9833	6583		
16880	13120	8640	9970	6590	21100	16270	10740	12340	8180		
7349	4782	3395	3240	2268	8495	5599	4080	3848	2741		
8488	5468	3823	3725	2582	9952	6473	4628	4453	3135		
9627	6153	4249	4222	2903	11410	7351	5172	5076	3539		
11700	7692	5206	5392	3654	14630	9331	6396	6548	4485		
12500	8537	5735	6063	4084	15630	10420	7069	7395	5026		
14400	10540	6994	7720	5145	18000	12980	8668	9490	6364		
15990	12190	8045	9153	6063	19980	15090	9997	11301	7520		
7223	4706	3347	3188	2233	8334	5503	4019	3783	2698		
9457	6051	4185	4148	2855	11190	7220	5091	4982	3478		
10710	6800	4651	4706	3214	12800	8183	5686	5684	3930		
12550	8588	5767	6105	4111	15690	10480	7110	7448	5060		
13960	10080	6703	7332	4896	17450	12390	8299	8999	6050		
14910	11070	7330	8174	5436	18630	13660	9093	10063	6730		
5418	3629	2666	2457	1755	6024	4155	3153	2880	2101		
7373	4796	3404	3251	2274	8526	5617	4091	3861	2749		
8473	5460	3818	3719	2578	9934	6462	4621	4445	3130		
11120	7066	4816	4908	3344	13370	8525	5898	5938	4093		
12390	8417	5660	5967	4022	15480	10260	6973	7274	4949		
13240	9319	6225	6700	4492	16550	11420	7693	8200	5540		
14210	10340	6867	7550	5036	17760	12730	8507	9275	6226		
3496	2501	1926	1718	1262	3909	2788	2226	1979	1490		
5067	3425	2535	2322	1665	5576	3903	2986	2713	1989		
5994	3970	2883	2685	1905	6762	4578	3428	3160	2288		
8260	5331	3738	3627	2519	9661	6298	4518	4331	3056		
10220	6506	4468	4484	3071	12160	7804	5452	5405	3751		
11330	7298	4961	5086	3458	13880	8824	6082	6163	4237		
12180	8197	5522	5791	3910	15230	9981	6798	7052	4807		
3175	2242	1750	1550	1148	3498	2481	2008	1777	1350		
3692	2648	2025	1814	1326	4135	2963	2348	2095	1570		
5565	3716	2721	2515	1793	6213	4262	3223	2950	2148		
7183	4681	3332	3171	2222	8282	5472	4000	3762	2685		
8290	5349	3749	3640	2527	9699	6321	4532	4346	3066		
9567	6117	4226	4196	2886	11330	7305	5144	5043	3517		
2401	1662	1341	1173	888	2510	1809	1512	1329	1033		
3403	2425	1874	1669	1228	3789	2697	2161	1920	1449		
4605	3159	2362	2146	1549	4985	3578	2769	2499	1845		
5515	3686	2703	2495	1780	6149	4226	3199	2926	2132		
6565	4310	3098	2916	2056	7492	5004	3702	3445	2476		

for CT, Proceedings of the 1st N. American Roundtable, SPE/CoTA, Montgomery, TX, February 25-28, 1996

3. Collapse Pressure data above is defined at S.F. = 1 & in absence of internal pressure.

$$(D_{\max} - D_{\min})/D$$

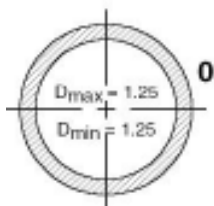
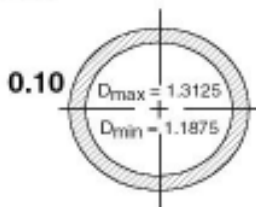
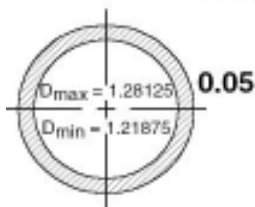
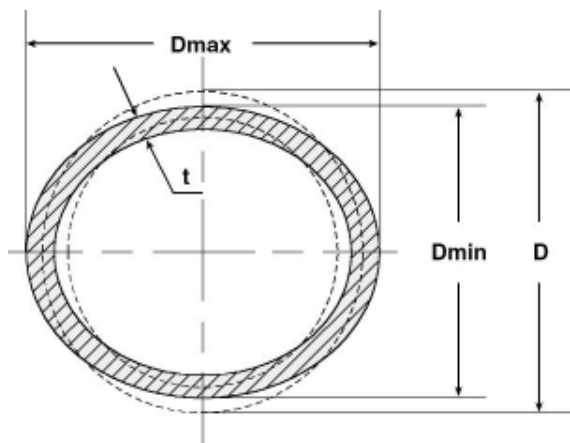

**MAXIMUM ALLOWABLE SAFETY FACTOR SF**

(Do not exceed chosen SF)

<b>Tubing Utilization Factor <i>UF, percent</i></b>		<b>Maximum Allowable <i>SF</i></b>
<i>Over</i>	<i>To</i>	
New CT	15	0.80
15	30	0.78
30	40	0.76
40	50	0.74
50	60	0.72
60	70	0.70
70	80	0.68
80	90	0.66
90 (Totally Worn CT)	100	0.64

**NOMENCLATURE**

C - elastic constant, *psi*

$$C := \frac{2E}{1 - \mu^2}$$

D - specified outside diameter (OD) of coiled tubing (CT), *in.*

DD - production maximum OD, *in.*

$$DD = D + 0.01 \text{ in.}$$

$D_{\max}$ ,  $D_{\min}$  - major and minor CT section diameters, *in.*

d - inside diameter, *in.*

$$d = D - 2t$$

$d_1$  &  $d_2$  - inside diameter at opposite ends of the tru-tapered segment, *in.*

$$d_1 = D - 2t_1$$

$$d_2 = D - 2t_2$$

E - modulus of elasticity,  $E=30 \cdot 10^6$  for steel CT

f - factor in collapse pressure calculations

$$f := \frac{\sigma_y K_y P_{ce}}{2M}$$

g - factor in collapse pressure calculations

$$g := \frac{\sigma_y K_y}{4M} + (2 + 3 \cdot \alpha \cdot Ov) \cdot \frac{P_{ce}}{4}$$

$K_y$  - yield strength correction factor

$$K_y := 2M \frac{P_i}{\sigma_y} + \sqrt{SF^2 - \frac{3}{4} \left( \frac{Q}{Q_y} + \frac{P_i}{\sigma_y} \right)^2} - \frac{1}{2} \left( \frac{Q}{Q_y} + \frac{P_i}{\sigma_y} \right)$$

M - CT factor, defined as

$$M := \frac{\alpha^2}{4(\alpha-1)}$$

Ov - CT ovality,

$$Ov = (D_{\max} - D_{\min}) / D$$

$P_c$  - collapse pressure for round tubing, is calculated using the appropriate of API Bul 5C3 [1]

$$P_c := \left( P_{yo}^{-2} + P_{ce}^{-2} \right)^{\frac{1}{2}}$$

$P_{ce}$  - elastic collapse pressure for round CT, *psi*

$$P_{ce} := .7125 \left[ \frac{C}{\alpha(\alpha - 1)^2} \right] + P_i$$

$P_{co}$  - collapse pressure for oval CT, *psi*

$$P_{co} = g - \sqrt{g^2 - f}$$

$P_i$  - applied internal pressure, *psi*

$P_y$  - CT yield internal pressure capacity, *psi*

$$P_y = \frac{\sigma_y}{\sqrt{4M^2 - 2M + 1}}$$

$P_{yo}$  - CT yield external pressure capacity, *psi*

$$P_{yo} := \frac{\sigma_y K_y}{2M}$$

$Q$  - applied axial force, *lb*

$Q_y$  - CT yield load capacity, *lb*

$$Q_y = \sigma_y \pi (DD - tt)tt$$

$SF$  - safety factor against failure. It is a utilized portion of the CT yield or collapse capacity when pressure, load, and/or torque are acting alone or simultaneously. It varies in the range 0 - $SF$ -1. Maximum of the factor,  $SF=S/S_y=1$ , means that design load or stress reached ultimate capacity, and therefore tubing can fail. The actual  $SF$  should never exceed allowable safety factor (see page 19):

$$SF = 0.8 \cdot 0.8 UF^{1.5}$$

$T_y$  - CT yield torque capacity, *lb-ft*

$$T_y = \frac{\sigma_y \pi}{192 \sqrt{3}} DD^3 [1 - (1-2/\alpha)^4] \text{ lb-ft}$$

$t$  - specified wall thickness, *in.*

$tt$  - production minimum wall thickness, *in.*

$$tt = t - 0.005 \text{ in.}$$

$t_1, t_2$  - specified wall thickness at opposite ends of the tru-tapered segment, *in.*

$V$  - displacement, material (metallic) volume occupied by 1000 ft long CT string,  $V=V_o-V_i$

$V_i$  - internal volume capacity of 1000 ft long CT string

$V_o$  - external volume capacity of 1000 ft long CT string

$W$  - CT weight, *lb/ft*

$$W = 10.68 (D - t)t \text{ lb/ft}$$

- $\alpha$  - D/t-ratio; for CT yield pressure, load, torque capacities, and CP evaluation

$$\alpha = \frac{DD}{tt} = \frac{\text{Production Maximum OD}}{\text{Production Minimum WT}}$$

- $\sigma_y$  - specified minimum yield strength in tension of CT, *psi*
- $\tau_y$  - specified minimum yield strength in shear of CT,  $\tau_y = \sigma_y / \beta$ , *psi*
- $\mu$  - Poisson's ratio,  $\mu = 0.30$  for steel

## ABBREVIATIONS

- CT - coiled tubing
- CP - collapse pressure
- ID - inside diameter
- OD - outside diameter
- WT - wall thickness
- UF - utilization factor, it is the ratio of the life already utilized, *l*, to the expected total CT life, *L*, that  $UF=l/L$ , where *l* and *L* are expressed in consistent units: calendar time, running feet, strokes over the gooseneck, etc. It may be estimated by experienced operator

## REFERENCES

1. American Petroleum Institute, BULLETIN ON FORMULAS AND CALCULATIONS FOR CASING, TUBING, DRILL PIPE AND LINE PIPE PROPERTIES. API Bulletin 5C3, Sixth Edition, October 1, 1994; 47 [CONTAINS ISO 10400:1993, PETROLEUM AND NATURAL GAS INDUSTRIES - FORMULAE AND CALCULATIONS FOR CASING, TUBING, DRILL PIPE, AND LINE PIPE PROPERTIES]
2. Timoshenko, S. STRENGTH OF MATERIALS. PART II - ADVANCED THEORY AND PROBLEMS. 2nd Ed., N.Y., Van Nostrand, 1954; 510
3. Timoshenko, S. WORKING STRESSES FOR COLUMNS AND THIN-WALLED STRUCTURES. Trans. ASME, *Applied Mechanics*, Vol. 1, 1993; 173-183
4. Avakov, V. and Fowler, H. COMPUTING COLLAPSE PRESSURE FOR COILED TUBING. SPE 36340, 1st North American Coiled Tubing Roundtable, Proceedings; Montgomery, TX; SPE/ICoTA, 1996; 7
5. ASvakov, V.A. EQUATIONS SHORTEN PIPE COLLAPSE CALCULATIONS. *Oil & Gas Journal*, Vol. 93, NO. 15, Apr. 10, 1995; 53-55
6. Avakov, V.A. and Taliaferro, W. EQUATIONS DETERMINE COILED TUBING COLLAPSE PRESSURE. *Oil & Gas Journal*, Vol. 93, No. 390, July 24, 1995; 36-39.